

stahl-electronics.com

# QUAD 1-10 *Version c*

*Rotating Wall Drive for Ion Compression  
in Traps*

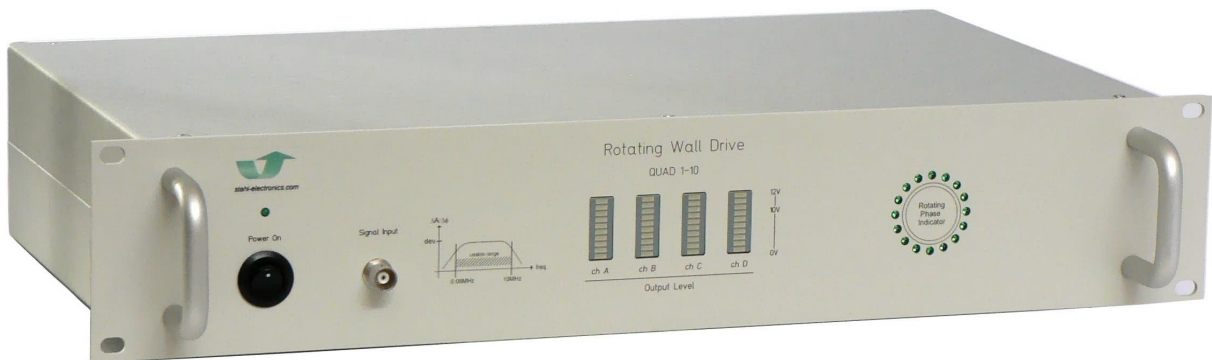

12 - Sept - 2017

## **User Manual**

Rev. 2.3



### **Main Features:**

- completely linear operating device
- provides 4 times 90°-phase shifted outputs
- voltage range 0 to 10V<sub>pp</sub>
- frequency range 80 kHz to 10 MHz

## TABLE OF CONTENTS

1. General Information and Overview .....	3
1.1 Introduction.....	3
1.2 Functional Principle and Block Diagram.....	3
1.3. Device Variety.....	5
2. Safety Hints .....	6
3. Installation .....	7
3.1. Mechanical Installation.....	7
3.2. Electrical Installation.....	7
4. Operation and Control Elements .....	8
4.1 Elements on the Front Plate.....	8
4.2 Rear Side Elements.....	9
4.3 Operation .....	9
5. Maintenance.....	11
6. Specifications.....	12
7. Related Devices.....	13
Appendix.....	14
Typical performance charts.....	14
Offset Circuitry .....	18
Declaration of Conformity .....	19

## 1. General Information and Overview

### 1.1 Introduction

The QUAD rotating wall drive is designed to create a rotating dipole or quadrupole electrical field inside a Penning Ion Trap. The resulting electrodynamical “rotating wall” enables fast compression of big ion clouds (see refs. [1], [2], [3]) after being loaded into a trap. The QUAD represents a tool to handle a wide range of ion/plasma rotational frequencies with respect to this novel application.

As indicated in the picture below, an input signal, for instance a sinusoidal wave, will be converted into an amplified 4-channel signal. All 4 channels have a phase relation of  $90^\circ$  and equal amplitude. In case a 4-segmented ring electrode is connected, a rotating dipole field is created, an 8-segmented ring will provide a rotating quadrupolar field. The nominal frequency range, in which a proper  $90^\circ$  phase shift from output to output is provided, covers about 80kHz to 10MHz, at a nominal output amplitude range of  $0V_{pp}$  to  $10V_{pp}$ . The signal input is 50 Ohm compatible, whereas the outputs do not require a 50 Ohm termination. Since the device is completely linear in terms of electronic signals, any combination or superposition of signals may be applied, e.g. dual-frequency signals or SWIFT signals. The rotating wall drive will individually create a phase shift of  $90^\circ$  at each frequency component.

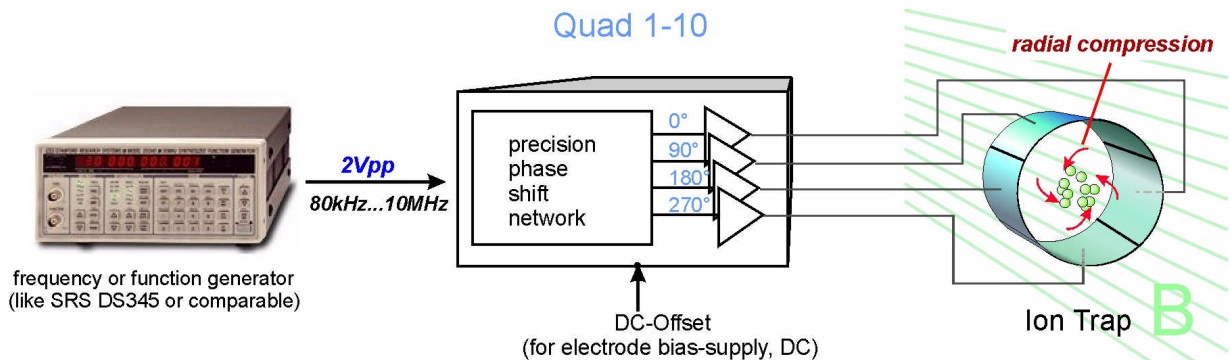

Fig. 1.1 Ion trap setup including a QUAD 1-10 rotating wall drive

### 1.2 Functional Principle and Block Diagram

The following picture displays the internal structure. After passing through an input amplifier, which performs a frequency response correction, an analog precision phase shift hybrid network creates 4 individual output lines having  $90^\circ$  of phase shift and equal amplitude. In principle *any* signal at the input, which lies within the nominal frequency and voltage range (80kHz to 10MHz; 0 ...  $2V_{pp}$ ) is suited for this application and will experience a 4-fold  $90^\circ$  phase shift. The internal analog phase shift network acts as a linear device in the electrodynamical sense and does not rely on non-linear effects or mixing processes.

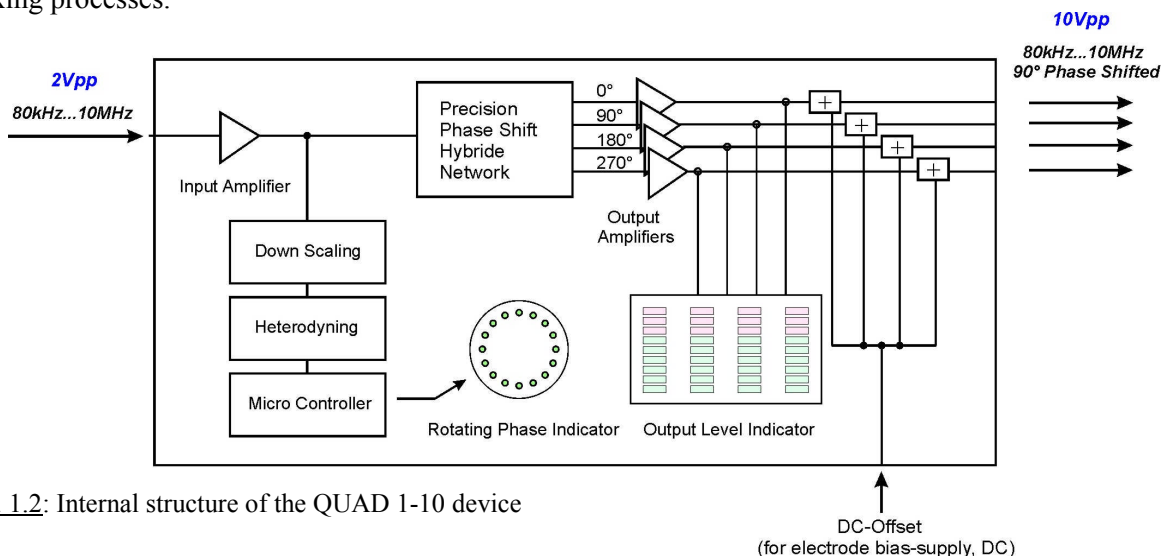

Fig. 1.2: Internal structure of the QUAD 1-10 device

For complex input signals, featuring many components in the frequency spectrum, all components will be phase-shifted *individually* without disturbing the other spectral components. This represents a considerable advantage over other ways of creating a rotating wall drive, like using several individual function generators. There is freedom to apply any signal in the nominal frequency and amplitude range without changing the device configuration or reprogramming. Complex spectra like SWIFT functions, sweeps, artificial noise and multi-tone signals may be applied, as pointed out already above.

After creating the individual phase shifts, four output buffers drive the outputs at the rear side, and allow for interfacing to an ion trap. A 50 Ohm termination at the output lines is not recommended. As an additional feature, a common DC-Offset-Input (rear side) for DC-Bias allows floating the 4 outputs up to +/-150 V on an additional DC level. LED indicators on the front plate show the presence of a suitable input signal and the corresponding output voltage level.

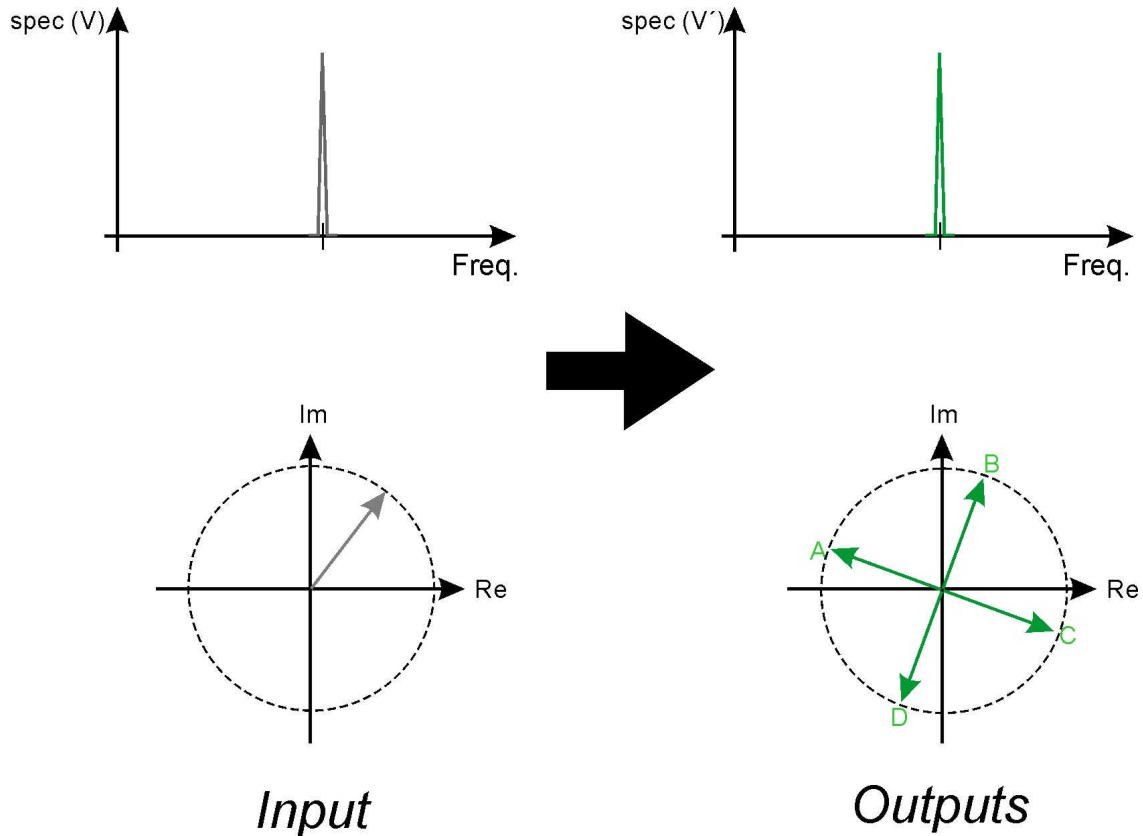

Fig. 1.3: Illustration of device functionality by comparing the input signal with the output signals. A sine wave with certain amplitude and frequency, fed in at the input, is converted into four 90° phase-shifted signals at the four outputs A-B-C-D. A constant phase relation of 90° and equal amplitude of the four output signals is maintained over a wide frequency range.

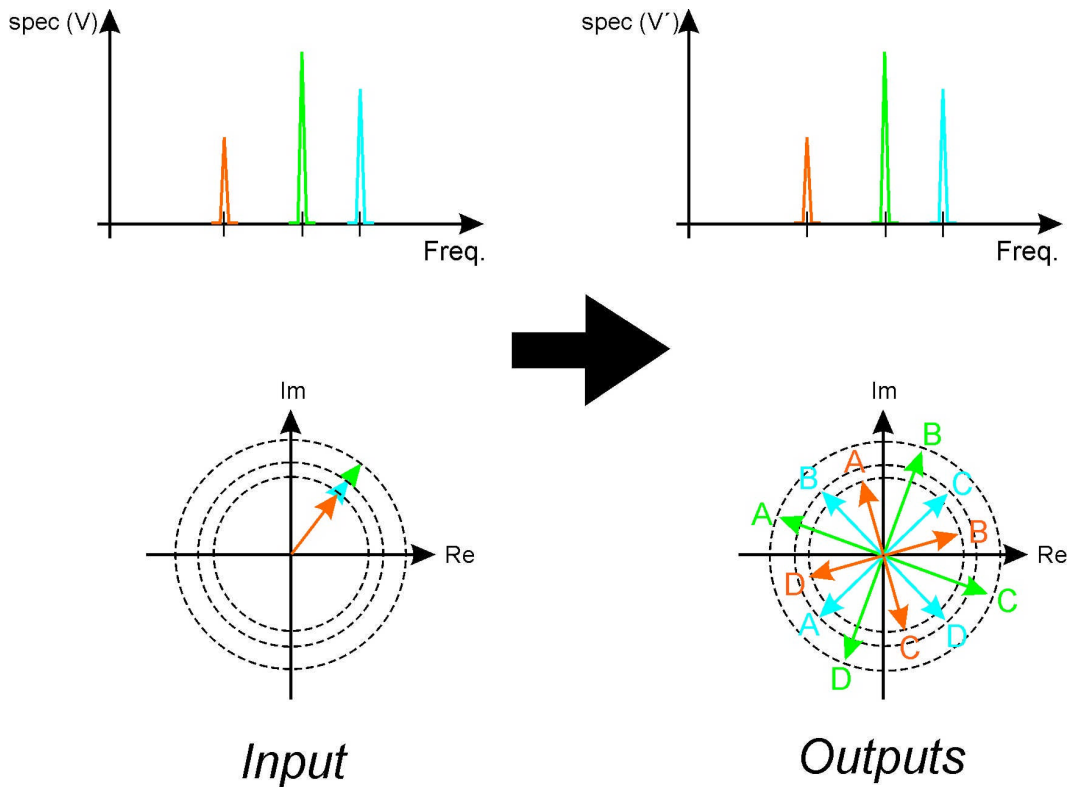

Fig. 1.4: Illustration of device functionality at a more complex input spectrum, here a 3-tone signal containing three sine waves with individual amplitudes, frequencies and phases. The device, due to its linear transfer function, is able to treat all input components individually, converting all of them one-by-one into four 90° phase-shifted signals at the outputs A-B-C-D. Phases and amplitudes of the spectral components do not disturb each other, but stay fixed (referring to phases), or proportional to the input components (referring to amplitudes) respectively.

### 1.3 Device Variety

Currently there several members of the QUAD 1-X series device family, in general the device parameters can be customized to user demands, in case necessary.

<b>Device Name</b>	<b>Versions</b>	<b>Characterstics</b>
<b>Quad 1-5</b>	Quad 1-5	Frequency Range 100kHz...5MHz Output Amplitude up to 20Vpp (at low frequencies)
	Quad 1-5b	Frequency Range 100kHz...5MHz Output Amplitude 20Vpp (entire frequency range)
<b>Quad 1-10</b>	Quad 1-10	Frequency Range 80kHz...10MHz Output Amplitude 10Vpp (entire frequency range)
	Quad 1-10c	as Quad 1-10, floating up to +/-5kV offset
<b>Quad 1-50</b>		Frequency Range 1MHz...50MHz
<b>Quad 30-100</b>		Frequency Range 30MHz...100MHz

Literature :

- [1] X.-P. Huang, F. Andereg, et al., Phys. Rev. Lett. 78, 875 (1997)
- [2] E.M. Hollmann et al., Phys. Plasmas 7, 2776 (2000)
- [3] Funakoshi et al.; Phys. Rev. A 76, 012713 (2007)

## 2. Safety Hints

Read all installation, operation, and safety instructions	Prior to operation, thoroughly review all safety, installation, and operating instructions accompanying this equipment.
Rear side switch turns device completely off	If the device is not in use for a longer time, it is recommended to turn the mains switch at the rear side off.
This equipment must be connected to an earth safety ground	This product is grounded through the grounding conductor of the power cord. To avoid electrical hazard, the grounding conductor must be connected to protective earth ground.
Do not modify the unit	Do not make electrical or mechanical modifications to this unit.
Do not operate in wet/damp conditions	To avoid electric shock hazard, do not operate this product in wet or damp conditions. Protect the device from humidity or direct water contact.
Beware of external magnetic fields	External magnetic fields can impair, damage or even destroy this device and cause fire hazard. A maximum external field strength of 10mT is admissible.
Service is to be performed by qualified service persons only	All servicing on this equipment must be carried out by factory-qualified service personnel only.
Disconnect power before servicing	To avoid electric shock hazard, disconnect the main power by means of the power switch and power cord prior to servicing.
Do not block chassis ventilation openings	Slots and openings in the chassis are provided for ventilation purposes to prevent overheating of the equipment and must not be restricted. All case vents should continuously be cleared (fan inlet at rear side, air outlet at rear side), in order to prevent overheating.
Operate carefully with respect to risk of electrical shock	In case the "DC Offset Input" at the rear side is used, voltages up to +/-150V <sub>DC</sub> will appear at the output lines, which are harmful in case of direct touch with the human body. Care must be taken to avoid unintentional touching of any output line by humans or any devices which might be endangered by high voltages. Even higher voltages may be present if device is equipped with high voltage offset input.
Routinely cleaning from dust	After long operation, or operation in a dusty environment it is strongly recommended to have the internal parts of the device cleaned by the manufacturer, or an appropriately qualified workshop in order to reduce the hazard of overheating and related risk of fire.
No outdoor operation	Outdoor operation of the device is not admissible.

### 3. Installation

#### 3.1. Mechanical Installation

Sufficient air cooling of the device has to be provided in order to prevent overheating. Rack mounting into a standard 19" rack is as well possible as resting the device on a table. All case vents must permanently be cleared (fan inlet at rear side, air outlet at rear side).

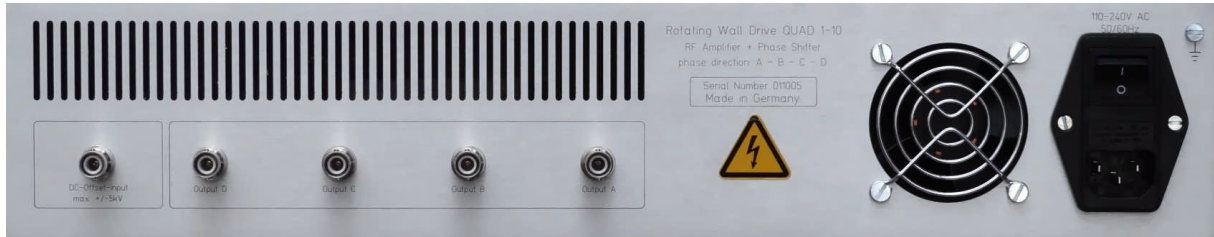

Fig. 3.1 rear side view:

Offset Input

Channel Outputs

Air Inlet

Mains Socket/switch

#### 3.2 Electrical Installation

##### Connecting to mains power:

Connect the device to the mains power supply by using an appropriate power cord with protection ground outlet. The power cord must be rated to at least 5A current.

##### Cabling of voltage outputs to ion traps:

Standard BNC cables (SHV in case of high DC offsets), or low capacitance cables may be used to connect the device to the experimental setup. Cables should be short in order to keep parasitic capacitances small and rf reflections down, which might otherwise impair the devices performance. Capacitive loads on the 4 outputs should be roughly matched ( $\pm 25\text{pF}$ ) and are recommended not to exceed  $300\text{pF}$  per cable. This restriction limits the cable length for standard BNC/SHV cables (RG58) to roughly 3m, the cable length for low capacitance cables, like MIN-RG59 or RG62, to 6m. Locating the device close to the trap setup is therefore necessary. Before turning the device on, ensure that the cabling can withstand the voltage being applied to the offset input.

A maximum external magnetic field of up to 10mT is admissible, in case the device is placed in the vicinity to a strong (e.g. superconducting) magnet with considerable fringe field. Higher B-fields can impair or even destroy magnetic parts like the ventilation fan and the internal power supply.

The “DC Offset-Input” at the rear side can be used to add a constant DC voltage to all outputs simultaneously. Please observe admissible DC ratings (maximum voltage) at this input. A stabilized DC voltage source with current limitation set to approx.  $10\mu\text{A}$  may be connected. In case this Offset Input is used, always be aware of the potential danger of high electrical voltages at the outputs to human beings and sensitive objects. A maximum admissible rate of voltage change of  $300\text{V}/\text{sec}$  should be observed, high voltage pulses and rf signals must not be applied to this input. At ratings higher  $1000\text{V}_{\text{DC}}$  a termination of this input (short- cut plug or  $50\Omega$ ) is recommended to prevent unintentional floating. In general wiring changes must be done only when the device is turned off, and the external DC offset is put to zero.

##### Phase orientation

The order, in which the QUAD 1-10 output phases propagate, is:  $A \rightarrow B \rightarrow C \rightarrow D$ , see also the following picture and figure 4.4. This orientation has to be matched to the ion species and direction of magnetic field inside the trap.

Fig.3.2

Phase orientation of the output signals. The direction of phase travel is  $A \rightarrow B \rightarrow C \rightarrow D$ .

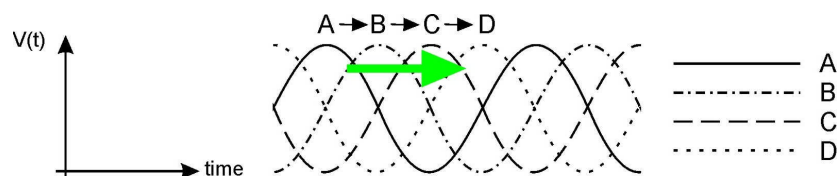



## 4. Operation and Control Elements

### 4.1 Elements on the Front Plate

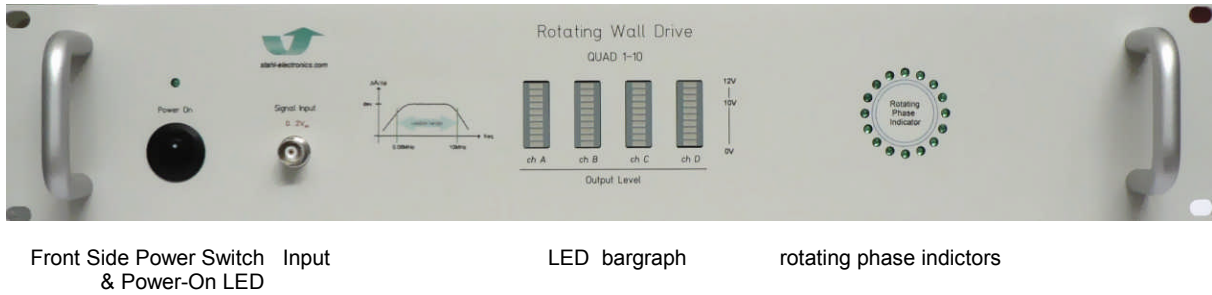
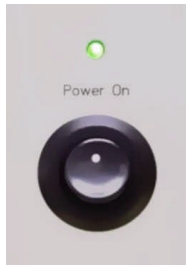

Fig. 4.1: Front plate

The front plate contains several control elements for the device.

#### Power Mains Switch



The device is powered up after turning on both the rear-side mains supply switch and also the power switch on the front plate. The Power-on-LED (green) indicates proper operation of the internal +24V supply circuitry.

If the device is not in use, it is recommended to switch it completely off with the rear side mains-switch. This will put the power consumption completely to zero and will avoid small supply currents which flow, when the rear side switch is kept on. Also for safety reasons (e.g. overvoltages occasionally occurring on the mains supply line) it makes sense to shut off the device completely by the rear side mains switch.

#### Signal Input

The Signal Input at the left hand side of the front plate is used to accept signals between 80kHz and 10MHz. The input impedance is roughly 50 Ohms, the input may be driven by a 50 Ohm output device like a standard function generator or RF signal generator. Voltage range is 0 to  $4V_{pp}$  nominally.

#### Rotating Phase Indicator

The Rotating Phase Indicator on the front side shows the principle function of the device and starts to rotate if a continuous input signal of at least  $15mV_{pp}$  amplitude is present. It rather is meant to give an impression of the devices basic functionality than being a precision indicating device. By means of internal frequency downscaling and heterodyning, the input frequency (80kHz to 10MHz) is brought to a visible frequency regime, otherwise the rotation would be too fast for noticing with the bare human eye.

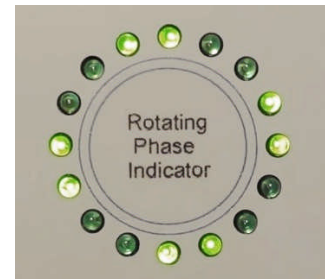

#### LED Level Indicators

The 4 LED Level Indicators deliver coarse information of the output voltage amplitude on the four output channels. They form linearly scaled rows of level thresholds, adjusted to a spacing of about 1.6

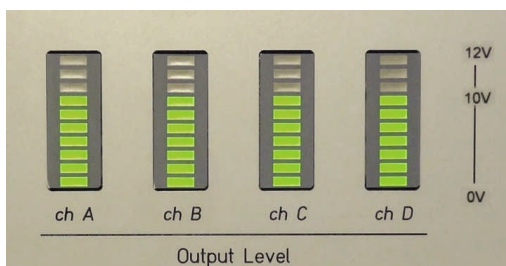

Volts. The nominal  $10V_{pp}$  output level is reached right before the first red LED segment is illuminated. Exceeding the green range (about  $10V_{pp}$ ) and going into the red range means bringing the output amplifiers to higher voltages while slowly going into saturation. This is a “smooth” and not a sudden process, which means that a slight overdrive at output levels above  $10V_{pp}$  might be still acceptable. See figure A 9 in Appendix for details about non-linearity at output levels exceeding  $10V_{pp}$ .



## 4.2 Rear side elements

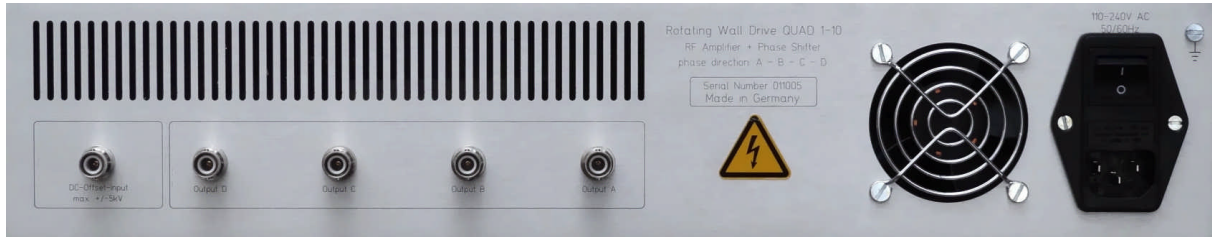

Fig. 4.2 rear side view:

Offset Input

4 Phase Shifted Outputs

Air Inlet

Mains Socket/Switch

The **outputs A, B, C and D** are implemented as standard BNC or SHV sockets and deliver the amplified and 90°-phase shifted signals for driving a rotating wall. The output impedance (AC-wise) is roughly 50 Ohms, nevertheless, there is no output 50 Ohms termination required or even recommended. In case a 50 Ohm termination is accidentally added, the output amplitudes will be decreased by a factor of two.

In case a DC-voltage is applied to the **external DC offset** voltage input, all AC output signals for rotating wall creation are linearly added (superposed) to this DC-voltage (max. +/-150V<sub>DC</sub>, higher if specially rated). If no DC-Offset is required and this input is left open, the output signals A, B, C, D will be centered around zero volts except for ratings higher 1000V<sub>DC</sub> at the offset input; here a termination of this input (short-cut plug or 50 Ohm) is strongly recommended to prevent unintentional floating or charge-up in case the input is not used. Note that this input is intended for constant DC offsets and not for pulses or RF signals. In case voltages higher +/-150V are applied to the DC offset input, make sure, they comply to a maximum admissible rate of voltage change of 300V/sec, in order to avoid excessive charging currents. See also appendix figure

## 4.3 Operation

After completing the wiring of the setup (see above) the power can be turned on (switch at rear side and switch on front plate) and the green “power on“ LED should lighten up. Arbitrary signals, e.g. from a function generator or rf-generator, in the frequency range between 80kHz and 10MHz and 4V<sub>pp</sub> may be applied to the input. All spectral signal components are individually converted into four 90° phase-shifted signals at the outputs. The output level on each channel can be monitored at the 10-element bargraph display at the front side and normally should be equal on all channels. For every signal component the phase relation between the four outputs (A-B-C-D), is 90° and the amplitudes are equal (further specifications see section 6 and appendix). The amplification factor is set to nominally  $V = 3 \text{ V/V}$  and a 150pF-loaded output (no 50 Ohm termination at outputs) is assumed.

Therefore, applying a signal between 0 Volts and 3.33 V<sub>pp</sub> at the input, will deliver output signals between 0 Volts and 10 V<sub>pp</sub> at output, assuming a capacitive load of about 150pF. Amplitude mismatch between neighbouring outputs is typically less than 2% (see diagrams A10, A11 in appendix) and phase mismatch around 2 to 5 degrees.

A typical input signal might be a swept sine wave, in order to “sweep” the rotational plasma frequencies inside the cloud of stored ions, being applied at a reasonable amplitude (e.g. 1V<sub>pp</sub>) and for a duration of a few seconds (also see fig. 4.3). A bandwidth-limited “white noise” signal is another example of an excitation signal, which in this case allows to excite all relevant plasma frequencies at the same time. Please see literature for further details.

- Lit. : [1] X.-P. Huang, F. Anderegg, et al., Phys. Rev. Lett. 78, 875 (1997)  
 [2] E.M. Hollmann et al., Phys. Plasmas 7, 2776 (2000)  
 [3] Greaves, Surko, Phys. Rev. Lett. 85, 1883–1886 (2000)  
 [4] Funakoshi et al., Phys. Rev. A 76, 012713 (2007)  
 [5] Saitoh et al., Phys. Rev. A 77, 051403 (2008)

**Attention: Make sure that the device is not permanently operated**

- (1) in the overrange-regime (bar indicators on front plate in red region),**
- (2) with input amplitudes larger than 5 V<sub>pp</sub> (5 Volts peak-to-peak)**
- (3) with input frequencies below 80kHz or above 10MHz**
- (4) Furthermore please observe the admissible DC voltage rating in case of using the DC offset input and maximum slew rate when changing the offset voltage.**

**Note that failure to comply with these limits may cause permanent damage of the device.**

**Signal Example: Swept sine wave**

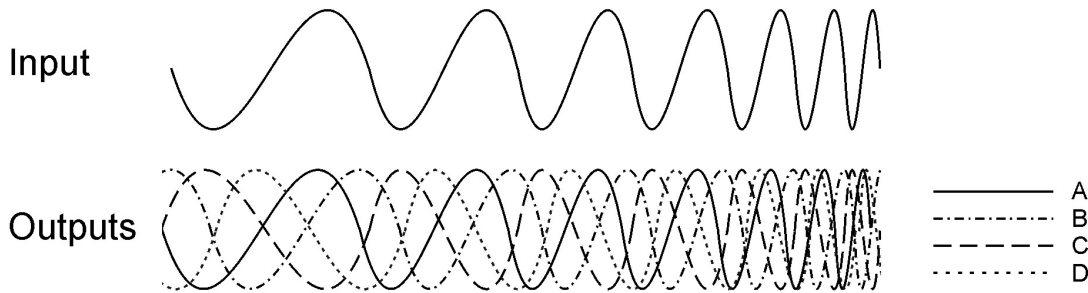

fig. 4.3 Example for a possible waveform; a swept sine wave may cover a broad frequency range in order to meet the plasma rotational frequencies, which might not be known precisely at the beginning. The sweep may be repeated several times to achieve the desired result of ion compression.

**Output assignment for dipole and quadrupole creation**

Depending on the intended application, the phase shifted outputs of the QUAD 1-10 device can be connected in different ways to a split electrode of a (e.g. cylindrical) Penning Trap. The following figure shows the principle assignment of the devices outputs (A,B,C,D) to electrode segments in case for a rotating dipole, and a rotating quadrupole arrangement. The rotational direction will be given by the phase order of the QUAD 1-10 outputs, namely A→B→C→D. Please observe that the plasma rotational orientation in a Penning Trap depends on the charge sign of the ion (or: charged particle) species and the magnetic field direction inside the trap, according to the direction of the Lorentz-force. Wrong orientation of the rotation will prevent success of the compression scheme.

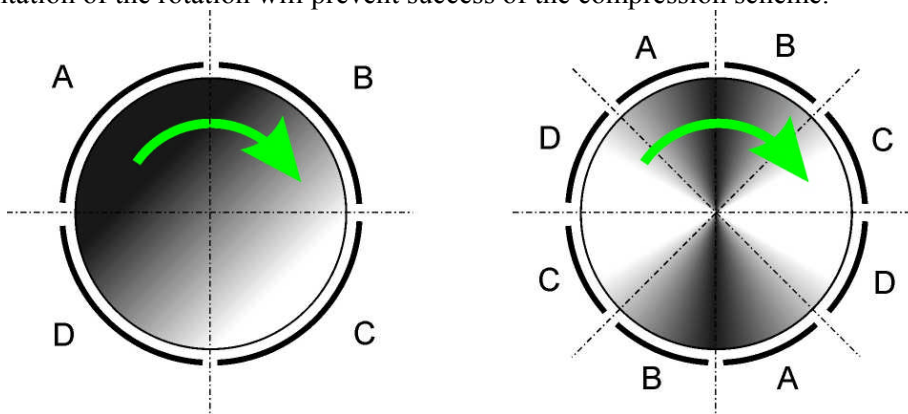

fig. 4.4

Graphical illustration of electric dipole/quadrupole creation. For a rotating electric dipole, connect the output lines (A,B,C,D) as shown in the left picture, for a quadrupole as shown in the right picture. Please observe the correct order while connecting the cables. The shading in the pictures above illustrates the momentary electric potential (dark: low; light: high).

## **5. Maintenance**

The QUAD DC 1-10 is designed for long term reliable operation. Under normal operating conditions, it should not require electrical maintenance, but routinely cleaning of dust, and in longer time intervals, periodic replacement of the rear ventilation fan (see below). If any further question should arise, please contact the manufacturer.

### **Routine cleaning**

All ventilation openings should be checked periodically for obvious obstacles and kept free of dust and other obstructions. A vacuum cleaner may be used to clean these vents when the unit is powered off. The front panel may be cleaned periodically with a clean cloth. It is recommended to send the device to the manufacturer routinely in 2-year intervals of operation for internal cleaning from dust. Visual inspection of the degree of internal pollution and accumulated dirt is possible, but should be carried out by qualified personnel. In this case wait at least 20sec. after switching power off (rear side switch), and disconnecting all external high voltage lines and the mains cable. After removing the 6 screws of the upper lid, the latter is removable and allows a view on the internal electronics boards. Very careful cleaning by qualified personnel and using a small miniature vacuum cleaner is admissible. Before continuing operation, ensure that the lid is placed correctly and that all 6 lid screws are placed and tightened again. In any doubt of possible internal damage contact manufacturer before continuing any further operation.

### **Fan life time**

The ventilation fan at the rear side of the housing is a part which shows considerable deterioration in time. Exchange of this part is recommended after latest 50.000 hours of operation. Please contact manufacturer for replacement after long term operation. Complete failure might lead to overheating and destruction of the device. A temperature fuse and other protection measures ensure a certain degree of safety against fire hazard in this case. Nevertheless, it is strongly recommended to regularly check the correct operation of the rear fan by simple visual inspection and checking of unexpected noise while in operation.

### **Fire hazard**

Please note, that excessive accumulation of dust inside the case of the device can lead to overheating and increases the risk of fire. Routinely cleaning the device from dust minimizes this risk. It is therefore recommended to send the device to the manufacturer routinely in 2-year intervals for internal cleaning from dust, or to have it cleaned by an accordingly qualified electrical workshop. Ambient air conditions containing oil mists (e.g. proximity to a vacuum forepump or mechanical machines) place a severe danger, since inflammable substances could enter the device through the ventilation holes and cause fire. If in doubt, cleaning by a qualified electrical workshop or the manufacturer is strongly recommended.

## 6. Specifications

Specifications Rotating Wall Drive QUAD 1-10c:

	Parameter	spec. value	Condition / Notes
	<b>Input (BNC connector)</b> Input Impedance Voltage Range Coupling Mode Frequency Range	50 Ohm 0...4V <sub>pp</sub> AC 80 kHz ... 10 MHz	Do not exceed 5V <sub>pp</sub> permanently
	<b>Outputs (BNC/SHV connectors)</b> Functionality  Voltage Range  Amplitude mismatch between outputs  Phase mismatch between outputs	4 Outputs, 90° Phase Shifted  0...10V <sub>pp</sub> nominally max. 13V (overrange) typ. < 0.2dB  max. ± 5° typ. 2.5°	output load 150pF each channel " f = 80 kHz .. 10 MHz "
	<b>Input/Output Relation</b> Voltage Gain Gain flatness over freq. range	nominally 3x (9.5dB)  typ. ±1.5dB	f = 80 kHz .. 10 MHz, each channel 150pF loaded "
	<b>Nominal Freq. Range</b>	80kHz...10MHz	output load 150pF each channel
	<b>Rotating Phase Indicator</b>	min. signal level typ. 10mV <sub>pp</sub>	f = 80 kHz .. 10 MHz
	<b>Wideband Output Noise, any channel</b>	2.2mV <sub>rms</sub>	bandwidth 1kHz ... 60MHz
	<b>Ext. DC-Offset range (BNC or SHV connector)</b>	± 150V <sub>DC</sub>  other on request	remark: the applied external offset (DC) voltage is internally added to the ac output voltages and will appear at the outputs as DC offset
		up to +/-5kV admissible rate of offset voltage change max +/-300V/sec.	Applicable if device is specially equipped with a high voltage offset stage and SHV connectors. Observe rating label on device.
	<b>Ext. DC-Offset input isolation resistance vs. GND</b>	typ. 100M to 10 GOhm depending on version	
	<b>Power Supply</b>	AC input 230V <sub>AC</sub> , 50Hz to 60 Hz. The power entry module is EMI/RFI-filtered. Fuse: slow blow 2A.  typical power consumption: 21 Watt	
	<b>Storage Temperature</b>	-55C° to +105C°	
	<b>Recommended Operating Humidity &amp; Temperature</b>	noncondensing relative humidity; ambient temperature between +10°C and +28°C	
	<b>External Magnetic Field</b>	max. 10mT	External magnetic field must <u>never</u> (at any time) exceed value given.
	<b>Physical Dimensions</b>	width x height x length approx. 485mm x 92mm x 310mm	
	<b>Weight</b>	approx. 3.0 kg	

## 7. Related Devices

### Voltage Sources

Stable multichannel voltage DC- and AC supplies for **Ion Traps, Ion Lenses, Quadrupoles and Beam Steerers** are also provided by the manufacturer. A special feature of the HV-Series devices (DC Supplies up to +/-500V) are the **bipolar** outputs with continuous zero crossing. This property makes the device well suited for ion optics like electrostatic steerers, benders or lenses. Computer control is provided by a USB connection and an easy operational graphical user interface.



**HV Series**  
16 channel bipolar voltage source +/-500V for ion optics and Penning Traps

### Image Charge Detection

Detection electronics are provided, including cryogenic versions for non-destructive image charge detection and FT-ICR applications.

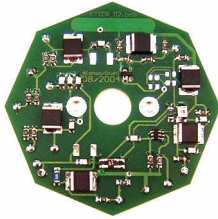

**FT-ICR Octagon**

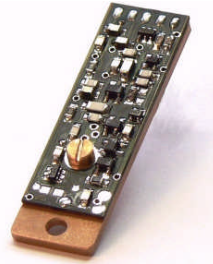

**NexGen3 - 4.2K-amplifier**

### Ultra stable DC- supplies

play a key role in high precision ion trap experiments, like g-factor determinations or ultra high precision mass measurements. The **UM 1-5** offers an unrivalled short term stability in the order of a **few times  $10^{-8}$** . Providing three ultra highly stable 25Bit-resolved channels of +/-14V range, this device represents a cost effective solution for DC-electrode supplies at precision ion traps. Computer control is provided by a USB connection and an easy operational graphical user interface.



## Appendix

### Typical performance charts

#### Output Waveforms

Measurement device for figures A1 to A7: Rigol oscilloscope DS1302CA

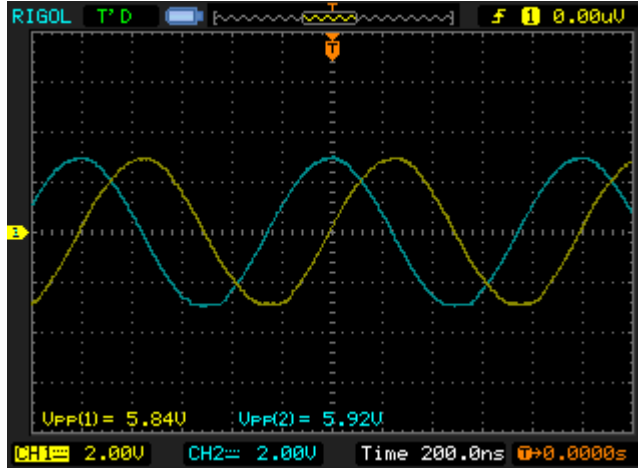

A1: Typical output waveform at 1MHz, 5.9Vpp output voltage, channels B and C

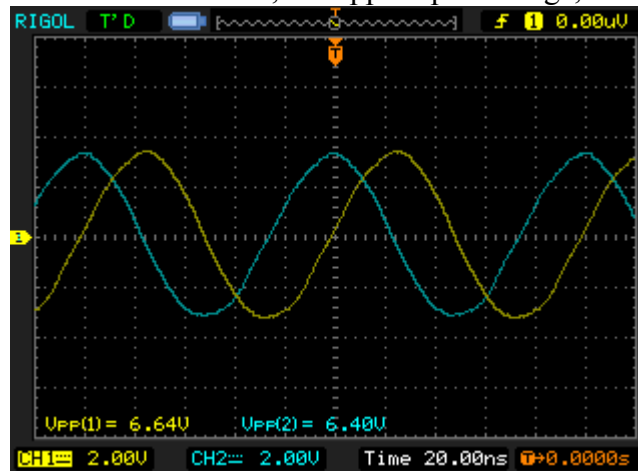

A2: Typical output waveform at 10MHz, 6.4Vpp output voltage, channels B and C

#### Oscilloscope screenshots in X-Y - Mode, channels B and C:

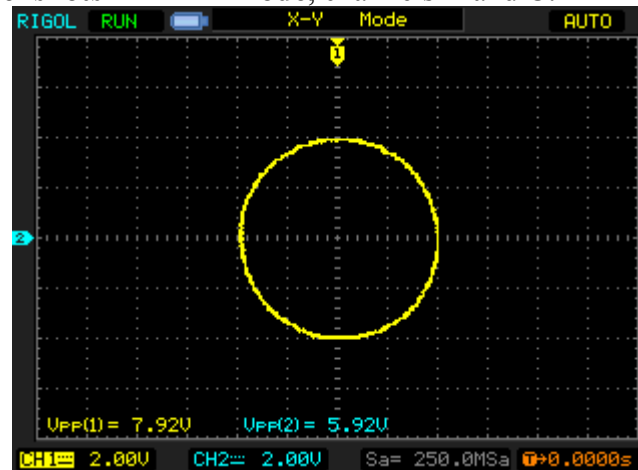

A3:  $f = 100\text{kHz}$

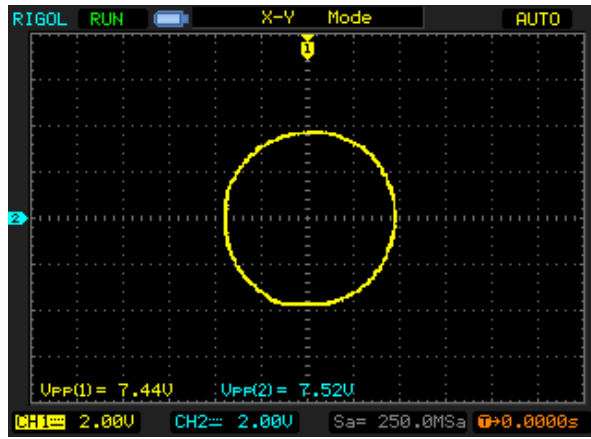

A4:  $f = 500\text{kHz}$

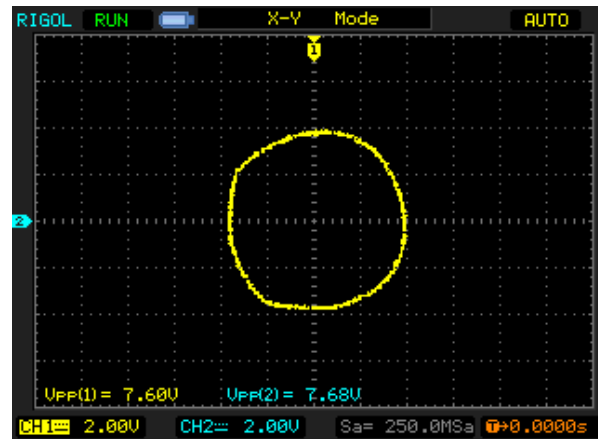

A5:  $f = 2\text{MHz}$

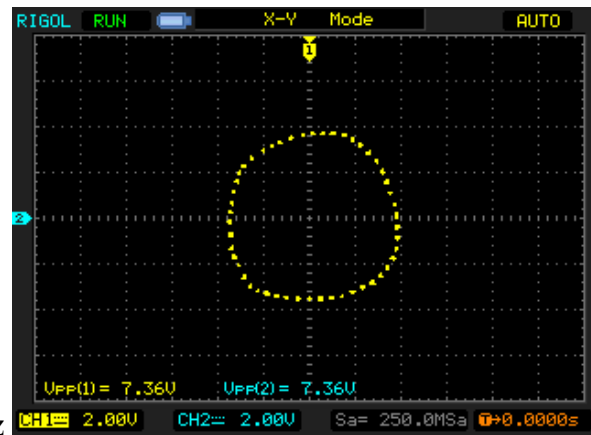

A6:  $f = 5\text{MHz}$

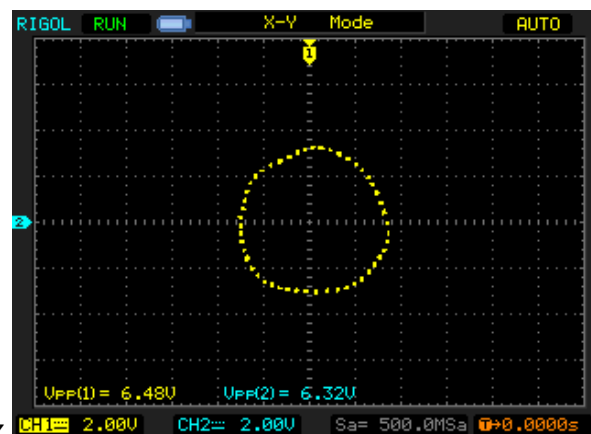

A7:  $f = 10\text{MHz}$



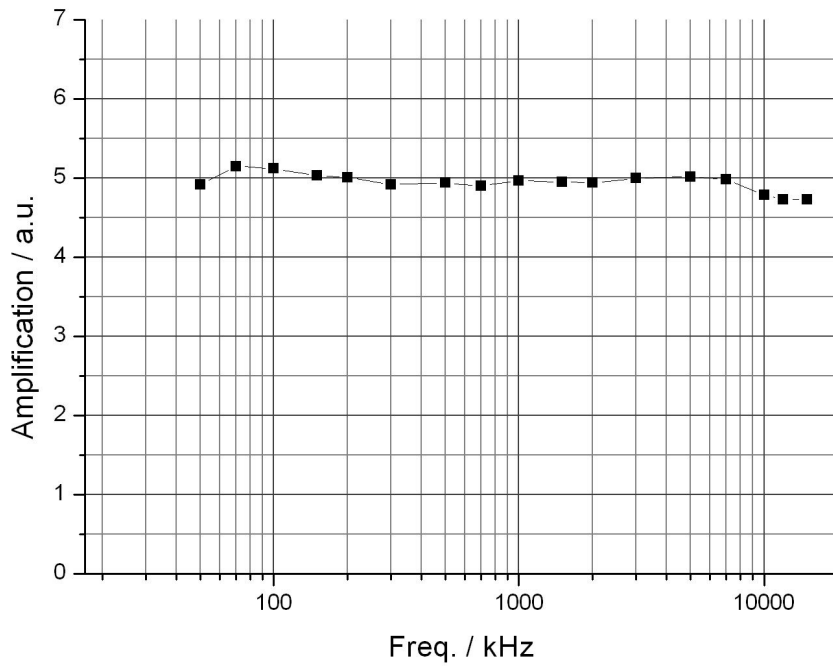

Fig. A8: Gain flatness vs. frequency  
 amplitudes are averaged over all output channels (A,B,C,D);  
 load on each channel: 150pF // 1M $\Omega$ m, measurement device: oscilloscope TDS 210 (Tektronix)

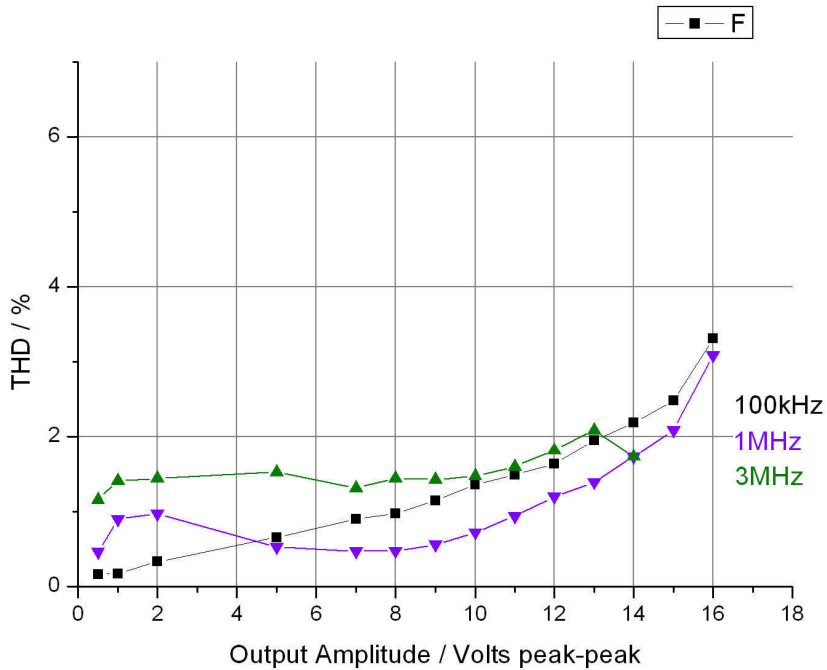

fig. A9: Non-linearity at high output levels (total harmonic distortion, THD)  
 load on output: 150pF // 10 M $\Omega$ m, measurement device: Picoscope 3224

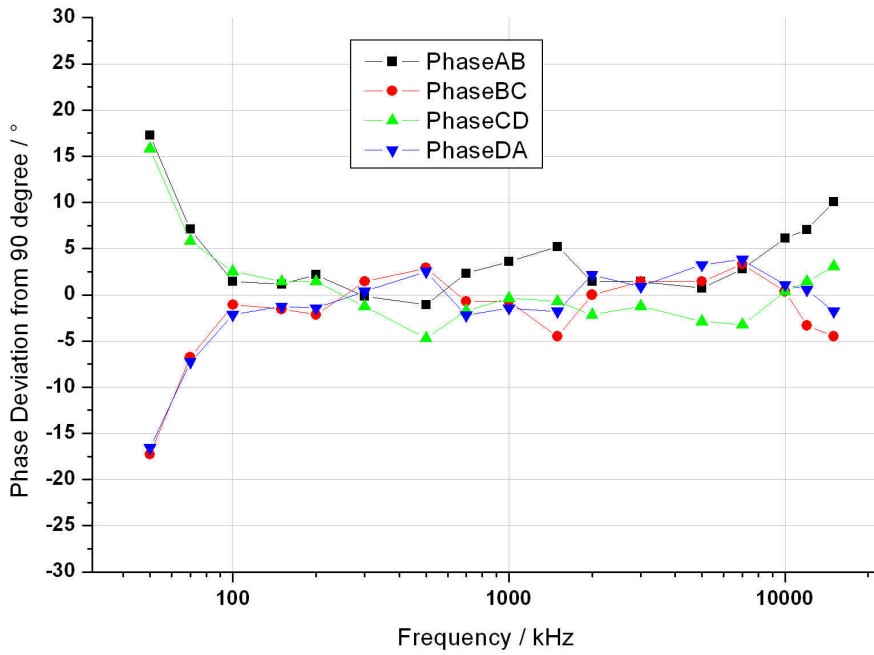

fig. A10: Phase error vs. frequency  
 Graph shows deviation from the nominal 90° shift between output channels  
 load on each channel: 150pF // 1MOhm;  
 measurement device: oscilloscope TDS 210 (Tektronix)

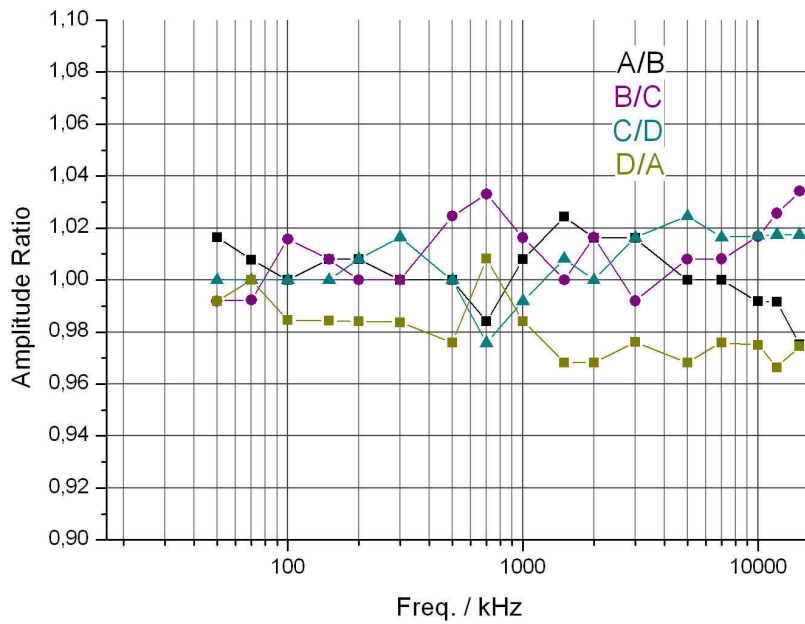

fig. A11: Amplitude mismatch vs. frequency  
 Graph shows voltage ratios between output channels  
 load on each channel: 150pF // 1MOhm;  
 measurement device: oscilloscope TDS 210 (Tektronix)

## Offset Circuitry

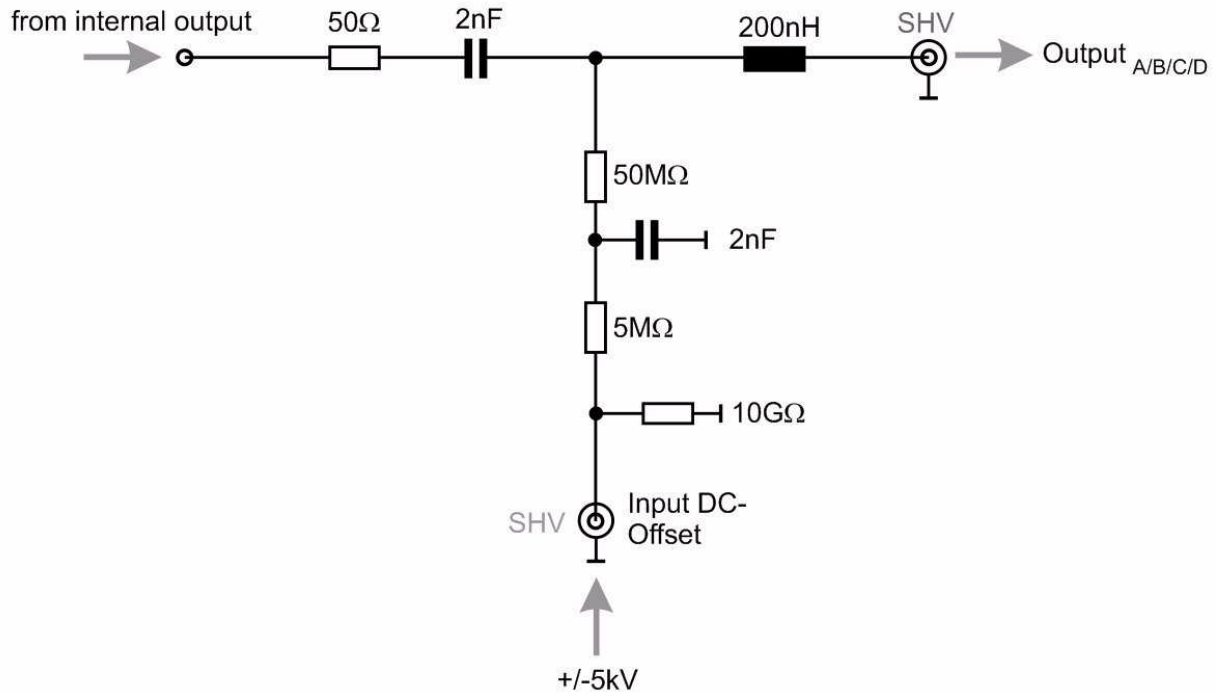

fig. A12: Circuit diagram of high voltage offset output stage. An externally supplied DC offset of up to  $\pm 5\text{kV}$  (max. value depends on rating) is filtered by a  $5\text{M}\Omega \times 2\text{nF}$  low pass and subsequently superposed to the AC signals from the internal phase shifter. Diagram shows one of four branches.

## DECLARATION OF CONFORMITY

**Manufacturer's Name:** Dr. Stefan Stahl  
- Electronics for Science and Research -

**Manufacturer's Address:** Kellerweg 23  
67582 Mettenheim  
Germany.

**Declares, that the product**

**Product Name:** Rotating Wall drive QUAD 1-10  
**Model Number:** QUAD 1-10

**Product Options:** This declaration covers all options of the above product(s)

**Conforms with the following European Directives:**

**The product herewith complies with the requirements of the:**

- 1. Low Voltage Directive 73/73EEC;**
- 2. EMC Directive 89/336/EEC (including 93/68/EEC) and carries the CE Marking accordingly**

**Date Of Issue**

**21. June 2011**

---

**General Director**